



**SPARE PARTS CATALOGUE
ERSATZTEILKATALOG
CATALOGUE PIECES DETACHEES
CATALOGO PARTI RICAMBIO
CATALOGO DE PIEZAS DE RECAMBIO
CATALOGO PECAS, DE REPOSICAO**

Catalogo parti di ricambio valido
dalla matricola 2982188 ad oggi (29/10/2021)

Catalogue pieces detachees
du numero de Série n. 2982188 jusqu'à aujourd'hui (29/10/2021)

Ersatzteilkatalog
gültig ab Serien-Nr. 2982188 bis heute (29/10/2021)

Spare parts catalogue
valid from serial no. 2982188 up today (29/10/2021)

Catálogo de peças de reposição
válido do número de série 2982188 até hoje (29/10/2021)

LV2535DBD

1

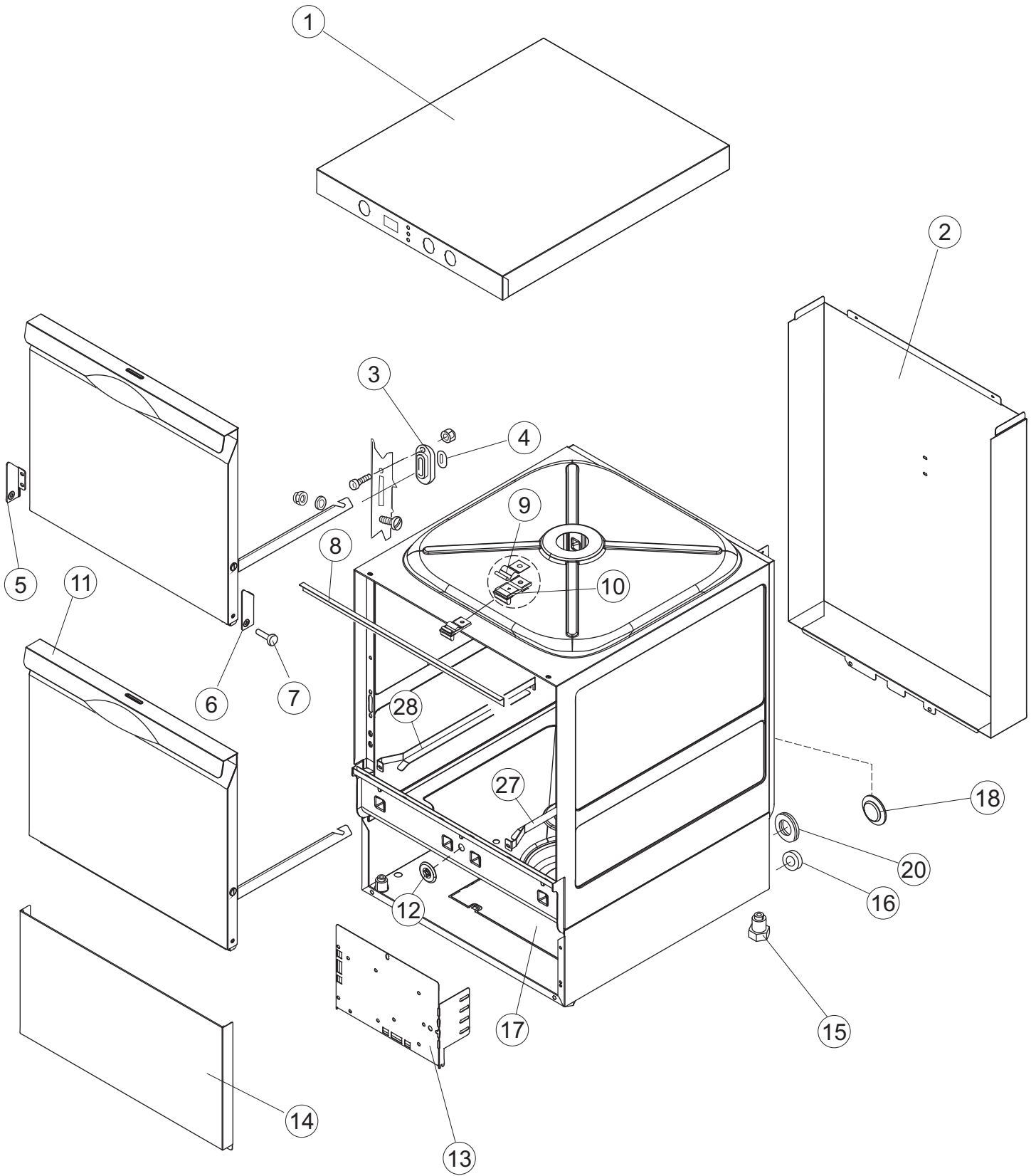

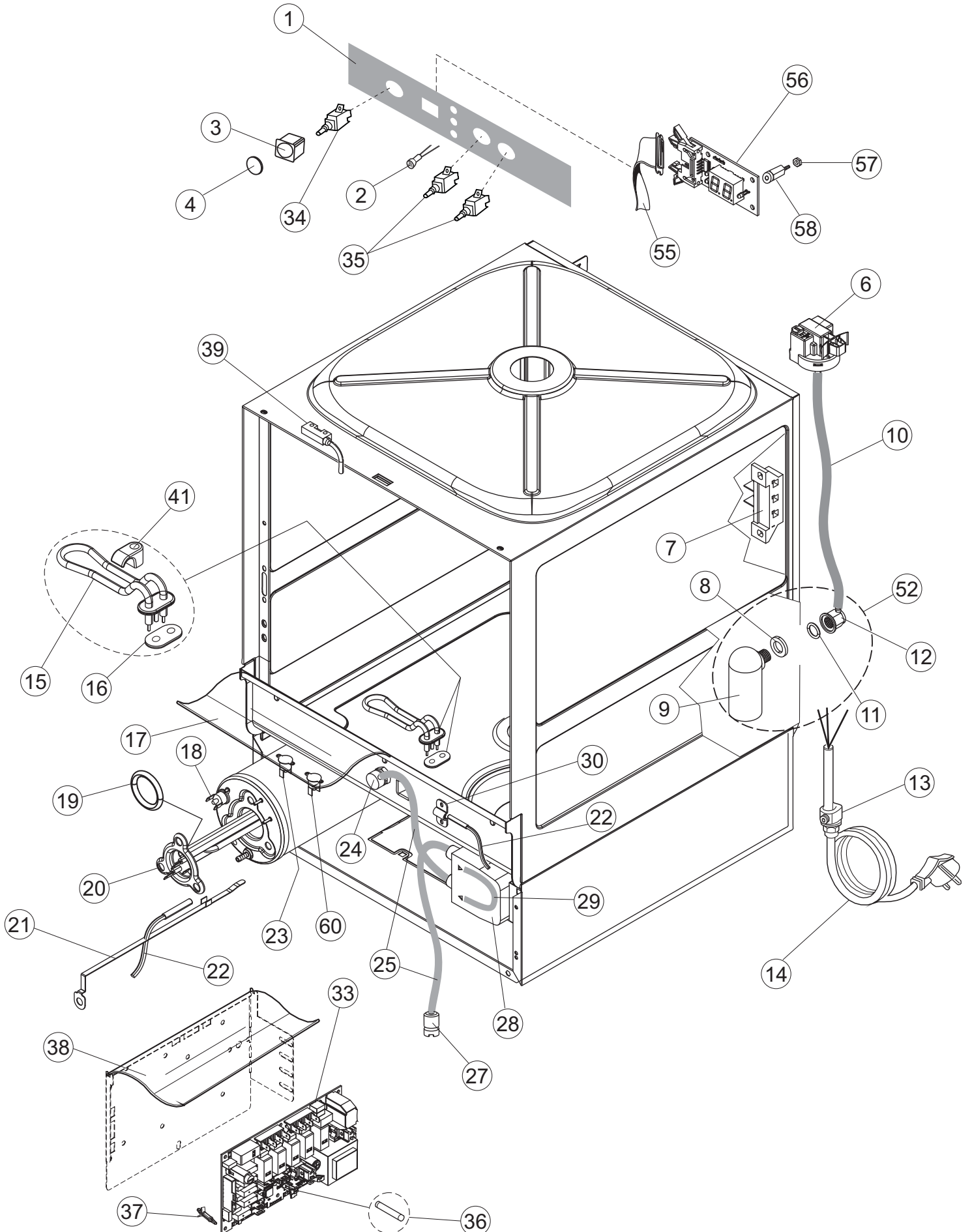

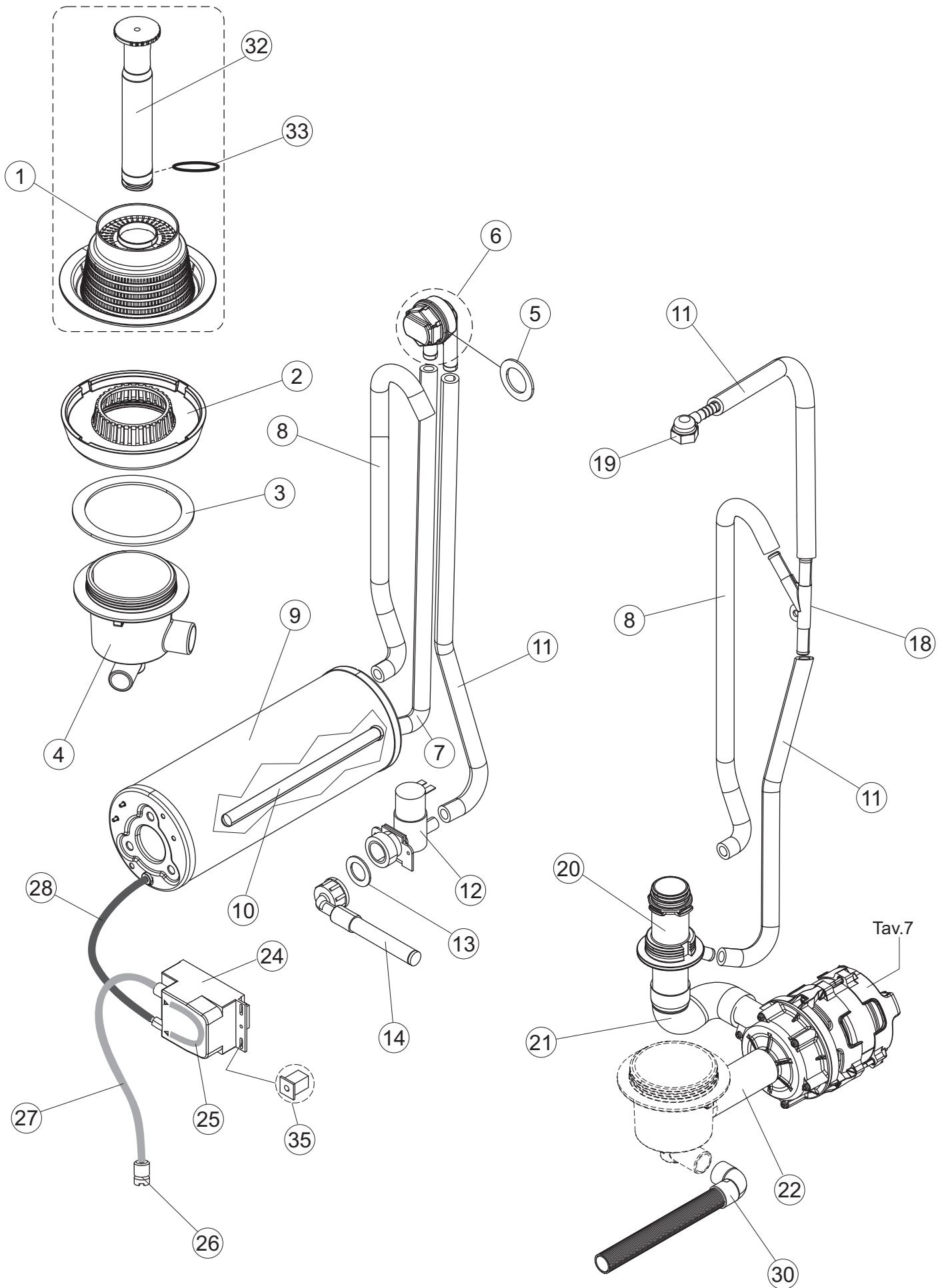

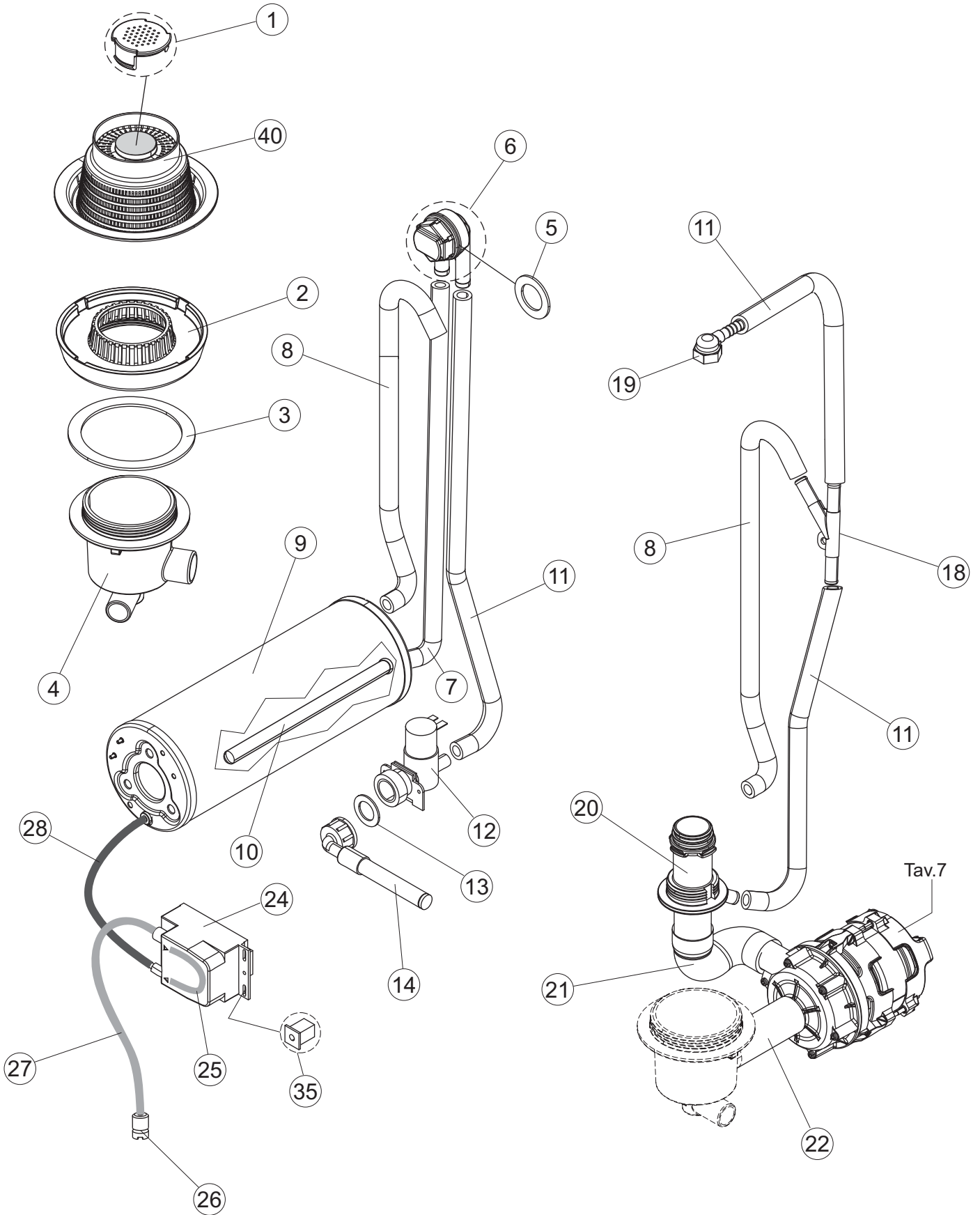

Drain Pump

LV 2535BD

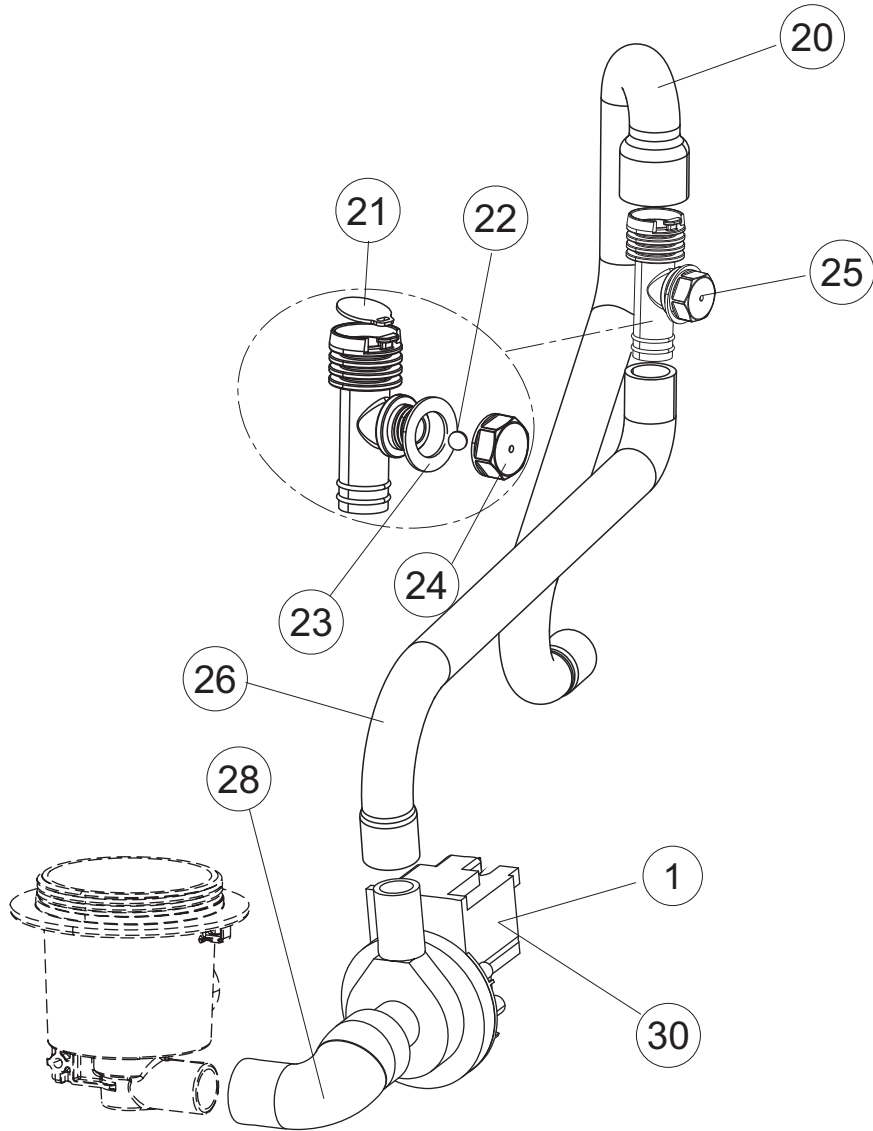

6

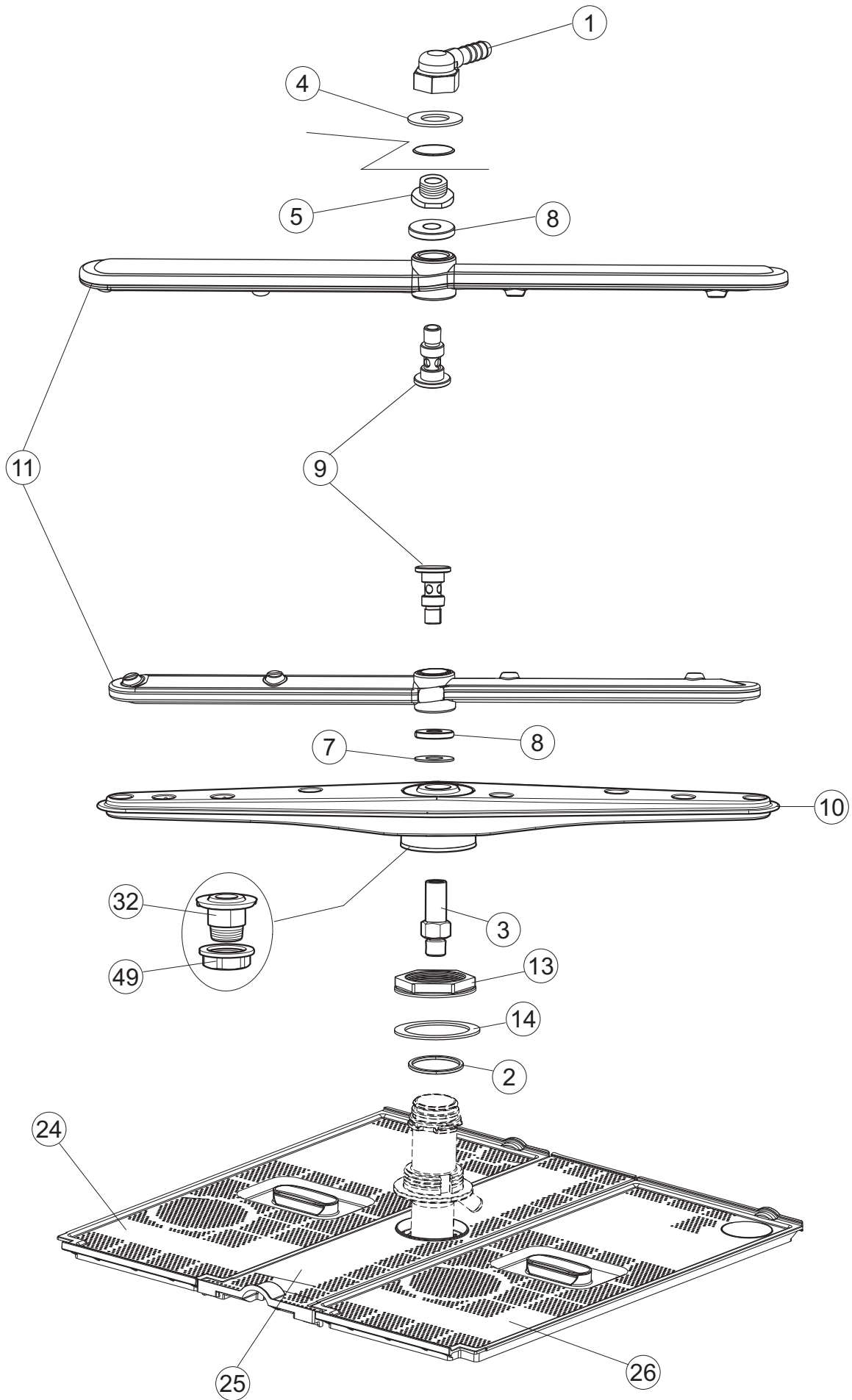

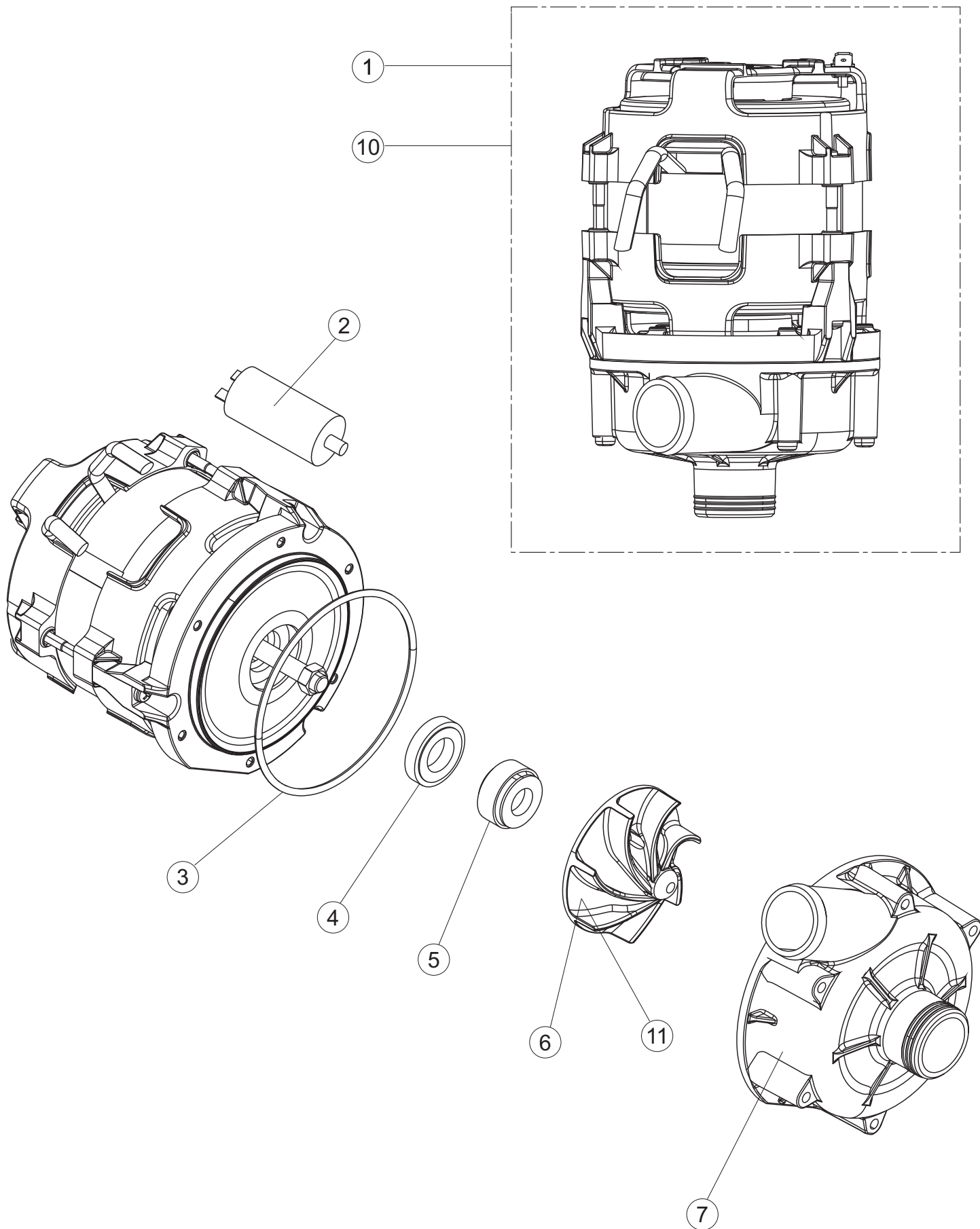

(*) Recommended spare part.

Page	Spare part position	Spare part code no.	Old code number	Description	U.m.
1	1	004340		COVER	NR
1	2	022166		BACK PANEL LA350	NR
1	3	307005		ROD OF TOP DOOR-STOP BAR	NR
1	4	028078		DOOR SHOULDER PLATE FOR GLASSWASHER	NR
1	5	311009		RIGHT DOOR HINGE FOR GLASSWASHERS	NR
1	6	311008		RIGHT DOOR HINGE FOR GLASSWASHERS	NR
1	7	325034		PIVOT	NR
1	8	437057		DOOR GASKET FOR GLASSWASHER	NR
1	9	449036		DOOR LOCK SPRING FOR GLASSWASHERS	NR
1	10	329012		DOOR LOCK FOR GLASSWASHERS	NR
1	11	029815		DOOR	NR
1	12	480153		PLUG	NR
1	13	035126		BRACKET	NR
1	14	012351		FRONT PANEL LA350	NR
1	15	461031		HEXAGONAL FOOT FOR GLASSWASHER	NR
1	16	459006		CHOCK D INT 9 EST 16	NR
1	17	030203		LOWER BASE PROTECTION LA350	NR
1	18	480084		PLUG	NR
1	20	459022		CABLEHOSE	NR
1	27	015073		RACK SLIDE DX.	NR
1	28	015074		RACK SLIDE SX.	NR
2	1	026947		CONTROL ADHESIVE INTERFACE	NR
2	2	216032		LAMP	NR
2	3	226126		PUSH BUTTON CASE	NR
2	4	227064		BUTTON	NR
2	6	224031		PRESSURE SWITCH	NR
2	7	220010		TERMINAL BLOCK	NR
2	8	437019		PACKING FOR AIR TRAP OF PRESSURE SWITCH	NR
2	9	107017		AIR TRAP FOR PRESSURE SWITCH	NR
2	10	143235		PIPE	MT
2	11	456020		O-RING	NR
2	12	468029		AIR TRAP CONNECTION OF PRESSURE SWITCH	NR

(*) Recommended spare part.

Page	Spare part position	Spare part code no.	Old code number	Description	U.m.
2	13	459005		CABLE-RETAINER	NR
2	14	299040		PLUG SCHUCKO 90- CABLE 1=2,5 MT	NR
2	15	230124		HEATING ELEMENT	NR
2	16	437086		PACKING OF THE TANK RESISTANCE	NR
2	17	214117		TRANSPARENT PROTECTION FOR ELECTRIC INSTALLATION FOR DISHWASHER	NR
2	18	236047		SAFETY TANK THERMOSTAT 95C	NR
2	19	456075		O-RING	NR
2	20	230113		HEATING ELEMENT	NR
2	21	69871		PROBE HOLDER	NR
2	22	231016		TEMPERATURE PROBE	NR
2	23	236061		THERMOSTAT 127	NR
2	24	999348		DETERGENT TANK FITTING	NR
2	25	143194		PIPE	MT
2	27	121993		FILTER AID DISPENSER	NR
2	28	209043		DETERGENT DOSING PUMP	NR
2	29	143258		"SANTOPRENE" PIPE	NR
2	30	028105		FIXING PLATE	NR
2	33	215042-4		MAIN BOARD GET50.2	NR
2	34	208010		DOUBLE SWITCH	NR
2	35	226071		CYCLE PUSH-BUTTON - 2 CONTACTS	NR
2	36	228010		FUSE	NR
2	37	461028		FOOT BOARD SUPPORT	NR
2	38	214077		TRANSP. SAFETY PLATE 44	NR
2	39	80871		MAGNETIC DOOR SWITCH	NR
2	41	999351		GROUP STOPPED TANK HEATER	NR
2	52	984009		PRESSURE SWITCH AIR BELL	NR
2	55	211017		FLAT CABLE	NR
2	56	74902		CONTROL KEYBOARD	NR
2	57	417119		NUT	NR
2	58	419036		INTERFACE BOARD DISTANCE KEEPERS	NR
2	60	236052		THERMOSTAT 90+/-3C	NR
3	1	121158		STAINER	NR

(*) Recommended spare part.

Page	Spare part position	Spare part code no.	Old code number	Description	U.m.
3	2	429077		RING NUT	NR
3	3	437107		GASKET	NR
3	4	136032		ASPIRATION AND DRAIN BODY	NR
3	5	437080		GASKET	NR
3	6	144030		NO RETURN VALVE	NR
3	7	143248		PIPE	NR
3	8	127178		BOILER PIPE LA400	NR
3	9	104056		BOILER	NR
3	10	143228		PIPE	NR
3	11	143004		PIPE	MT
3	12	240011		FILL VALVE	NR
3	13	437041		GASKET	NR
3	14	143270		INLET WRAS PIPE	NR
3	18	143268		JUNCTION "Y"	NR
3	19	468165		UPPER RINSE PIPE CONNECTOR	NR
3	20	115152		MAIN MANIFOLD	NR
3	21	127181		DELIVERY HOSE WASHING PUMP	NR
3	22	127182		PUMP INLET HOSE LA350	NR
3	24	209042		DOSING PUMP	NR
3	25	143261		HOSE	NR
3	26	121993		FILTER AID DISPENSER	NR
3	27	H.775601		PIPE	MT
3	28	143005		LINEN RUBBER PIPE 5X12 - BLACK	MT
3	30	127184		DRAIN HOSE	NR
3	32	142060		TROPPO PIENO LA400	NR
3	33	456080		O-RING	NR
3	35	431007		CLIPS	NR
4	1	480161		PLUG	NR
4	2	429077		RING NUT	NR
4	3	437107		GASKET	NR
4	4	136032		ASPIRATION AND DRAIN BODY	NR
4	5	437080		GASKET	NR

(*) Recommended spare part.

Page	Spare part position	Spare part code no.	Old code number	Description	U.m.
4	6	144030		NO RETURN VALVE	NR
4	7	143248		PIPE	NR
4	8	127178		BOILER PIPE LA400	NR
4	9	104056		BOILER	NR
4	10	143228		PIPE	NR
4	11	143004		PIPE	MT
4	12	240011		FILL VALVE	NR
4	13	437041		GASKET	NR
4	14	143270		INLET WRAS PIPE	NR
4	18	143268		JUNCTION "Y"	NR
4	19	468165		UPPER RINSE PIPE CONNECTOR	NR
4	20	115152		MAIN MANIFOLD	NR
4	21	127181		DELIVERY HOSE WASHING PUMP	NR
4	22	127182		PUMP INLET HOSE LA350	NR
4	24	209042		DOSING PUMP	NR
4	25	143261		HOSE	NR
4	26	121993		FILTER AID DISPENSER	NR
4	27	H.775601		PIPE	MT
4	28	143005		LINEN RUBBER PIPE 5X12 - BLACK	MT
4	35	431007		CLIPS	NR
4	40	121162		STAINER	NR
5	1	130206		DRAIN PUMP (9010722)90220/240-50	NR
5	20	127183		SLEEVE	NR
5	21	499092		DIAPHRAGM VALVE VENT	NR
5	22	476008		SPHERE	NR
5	23	437083		GASKET	NR
5	24	468199		PIPE FITTING	NR
5	25	144992		NO RETURN VALVE	NR
5	26	127185		SLEEVE	NR
5	28	127174		SLEEVE	NR
5	30	130215		PRICE TO BE DEFINED	
6	1	468165		UPPER RINSE PIPE CONNECTOR	NR

(*) Recommended spare part.

Page	Spare part position	Spare part code no.	Old code number	Description	U.m.
6	2	303018		SEALING AND SLIDING RING CL.3	NR
6	3	325097		PIVOT	NR
6	4	437078		GASKET	NR
6	5	429050		RING NUT	NR
6	7	437117		WASHER	NR
6	8	80697		RING NUT	NR
6	9	80700		PIVOT	NR
6	10	990121		WASH ASSEMBLY	NR
6	11	129077		RINSE ARM	NR
6	13	429079		RING NUT	NR
6	14	437108		GASKET	NR
6	24	121160		STAINER	NR
6	25	121159		STAINER	NR
6	26	121165		STAINER	NR
6	32	417129		UNION NUT WASH/RINSE ARM	NR
6	49	308031		RING NUT	NR
7	1	130197		PUMP LA350 230/50-1N	NR
7	2	206013		CAPACITOR	NR
7	3	456088		O-RING PACKING FOR WASH-PUMP	NR
7	4	141018		WASH PUMP SHAFT SEAL FOR GLASSWASHER	NR
7	5	141019		WASH PUMP SHAFT SEAL FOR GLASSWASHER	NR
7	6	124074		ELECTROPUMP IMPELLER 50HZ	NR
7	7	116043		ELECTROPUMP HOUSING	NR
7	10	130198		PUMP	NR
7	11	124077		PRICE TO BE DEFINED	